

# 11HS SERIES 1.8°

## Key Features

- High Accuracy
- Low Inertia
- Small Size

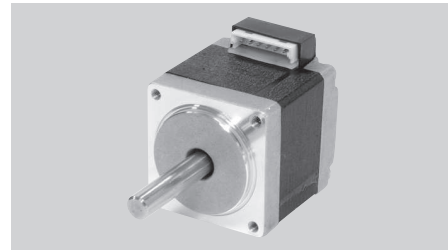

## General Specifications

- Bi-polar

Series & Length	Model Number	Holding Torque		Rated Current	Resistance per Phase	Inductance per Phase	Detent Torque		Rotor Inertia	
		mNm	oz-in	A	ohm	mH	mNm	oz-in	g.cm <sup>2</sup>	oz-in <sup>2</sup>
11HS1 31 mm (1.22 in.)	11HS1006	65	9.21	0.67	5.6	4.3	5	0.71	9	0.05
	11HS1007	65	9.21	0.5	10.4	8.4				
	11HS1008	65	9.21	1	2.5	2.2				
11HS3 40 mm (1.57 in.)	11HS3005	105	14.88	0.67	6.8	6.0	6	0.85	12	0.07
11HS5 51 mm (2.01 in.)	11HS5005	120	17.01	0.5	12	12	8	1.13	18	0.10
	11HS5007	120	17.01	0.25	48.5	30.7				
	11HS5008	120	17.01	1	3.5	2.3				

- Uni-polar

Series & Length	Model Number	Holding Torque		Rated Current	Resistance per Phase	Inductance per Phase	Detent Torque		Rotor Inertia	
		mNm	oz-in	A	ohm	mH	mNm	oz-in	g.cm <sup>2</sup>	oz-in <sup>2</sup>
11HS1 31 mm (1.22 in.)	11HS1003	53	7.51	0.95	2.8	1.3	5	0.71	9	0.05
	11HS1009	34	4.82	0.25	40	12				
	11HS1010	34	4.82	0.5	9.4	3				
11HS3 40 mm (1.57 in.)	11HS3002-01	80	11.34	0.95	3.4	1.6	6	0.85	12	0.07
11HS5 51 mm (2.01 in.)	11HS5002-01	115	16.30	0.95	4.6	2.3	8	1.13	18	0.10
	11HS5003	90	12.76	0.5	12	6.3				

- Wiring Connection, Lead Wires, Schematic Diagrams & Stepping Sequence.....Page 62 - 64

## Mechanical Dimension

Series	L	Mass
	mm (in.)	kg (lb.)
11HS1	31 (1.21)	0.10 (0.22)
11HS3	40 (1.56)	0.15 (0.33)
11HS5	51 (2.01)	0.20 (0.44)

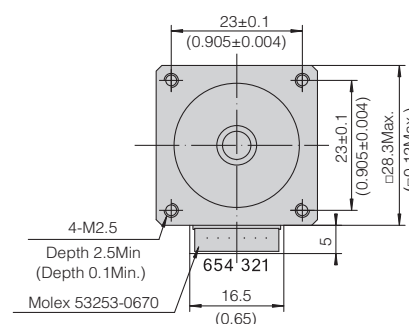
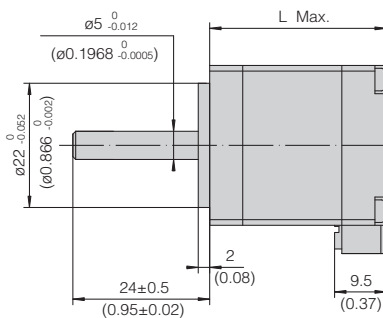

Unit: mm(inch)

Why Stepping Motor

encapsulated 2 phase NEMA 14

encapsulated 3 phase NEMA 14 NEMA 17

new release 2 phase NEMA 8

new release 2 phase NEMA 14

new release 2 phase NEMA 16

2 phase NEMA 10 25.0 mm (1.00 inch)

2 phase NEMA 11 28.0 mm (1.10 inch)

2 phase NEMA 14 35.0 mm (1.38 inch)

2 phase NEMA 16 39.0 mm (1.53 inch)

2 phase NEMA 17 42.0 mm (1.65 inch)

2 phase NEMA 23 56.0 mm (2.22 inch)

2 phase NEMA 24 60.0 mm (2.36 inch)

2 phase NEMA 34 86.0 mm (3.39 inch)

3 phase NEMA 24 60.0 mm (2.36 inch)

3 phase NEMA 34 86.0 mm (3.39 inch)

how to select

## Dynamic Torque Curves

- Bi-polar

### 11HS1006

Conditions: Bi-polar Constant Current Driver  
Driver: AMA MS3540M  
Mode: Full Step

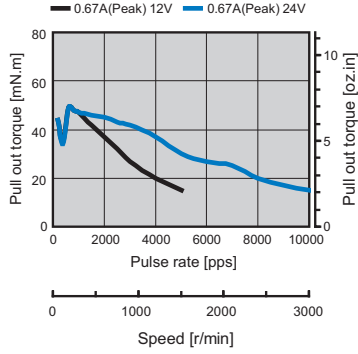

### 11HS1007

Conditions: Bi-polar Constant Current Driver  
Driver: AMA MS3540M  
Mode: Full Step

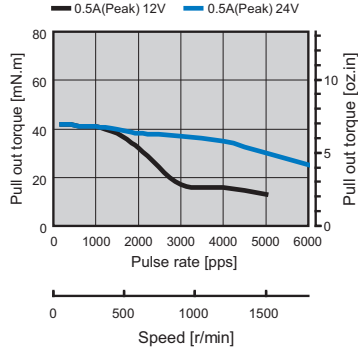

### 11HS1008

Conditions: Bi-polar Constant Current Driver  
Driver: AMA MS3540M  
Mode: Full Step

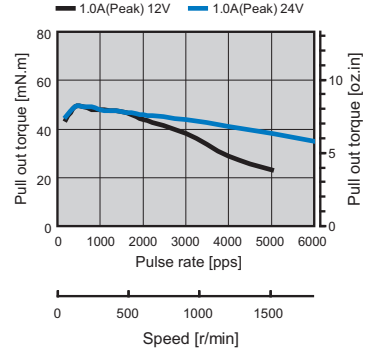

### 11HS3005

Conditions: Bi-polar Constant Current Driver  
Driver: AMA MS3540M  
Mode: Full Step

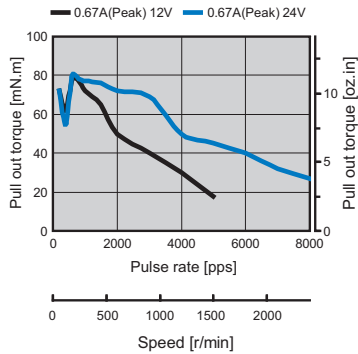

### 11HS5005

Conditions: Bi-polar Constant Current Driver  
Driver: AMA MS3540M  
Mode: Full Step

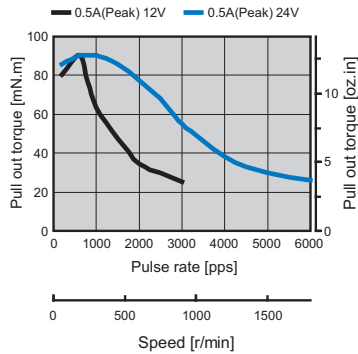

### 11HS5007

Conditions: Bi-polar Constant Current Driver  
Driver: AMA MS3540M  
Mode: Full Step

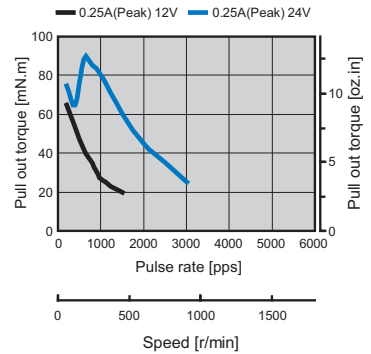

### 11HS5008

Conditions: Bi-polar Constant Current Driver  
Driver: AMA MS3540M  
Mode: Full Step

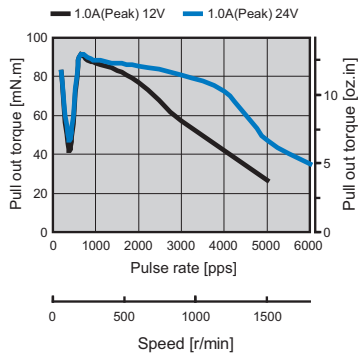

Why Stepping Motor

encapsulated 2 phase NEMA 14

encapsulated 3 phase NEMA 14 NEMA 17

new release 2 phase NEMA 8

new release 2 phase NEMA 14

new release 2 phase NEMA 16

2 phase NEMA 10 25.0 mm (1.00 inch)

2 phase NEMA 11 28.0 mm (1.10 inch)

2 phase NEMA 14 35.0 mm (1.38 inch)

2 phase NEMA 16 39.0 mm (1.53 inch)

2 phase NEMA 17 42.0 mm (1.65 inch)

2 phase NEMA 23 56.0 mm (2.22 inch)

2 phase NEMA 24 60.0 mm (2.36 inch)

2 phase NEMA 34 86.0 mm (3.39 inch)

3 phase NEMA 24 60.0 mm (2.36 inch)

3 phase NEMA 34 86.0 mm (3.39 inch)

how to select

## Dynamic Torque Curves

- Uni-polar

### 11HS1003

Conditions: Uni-polar Constant Current Driver  
Driver: AMA MSU3040M  
Mode: Full Step

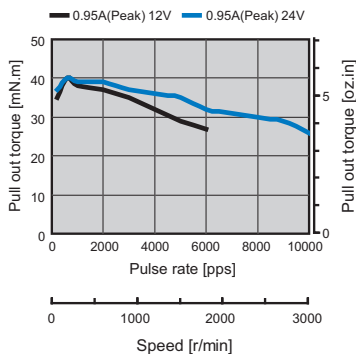

### 11HS1009

Conditions: Uni-polar Constant Current Driver  
Driver: AMA MSU3040M  
Mode: Full Step

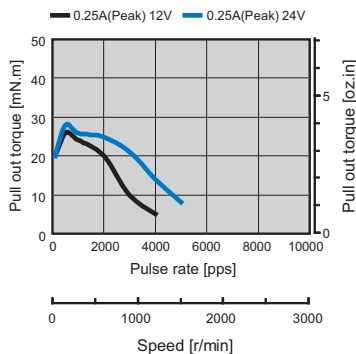

### 11HS1010

Conditions: Uni-polar Constant Current Driver  
Driver: AMA MSU3040M  
Mode: Full Step

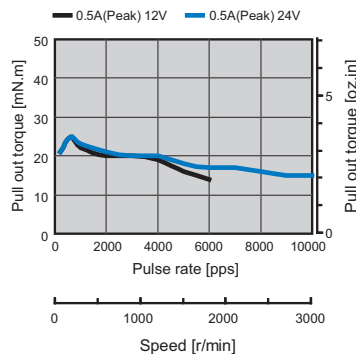

### 11HS3002-01

Conditions: Uni-polar Constant Current Driver  
Driver: AMA MSU3040M  
Mode: Full Step

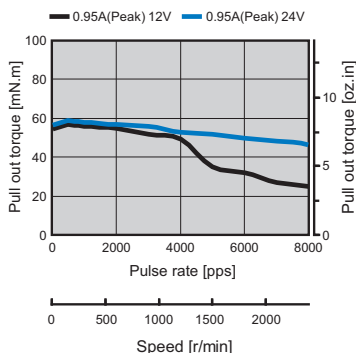

### 11HS5002-01

Conditions: Uni-polar Constant Current Driver  
Driver: AMA MSU3040M  
Mode: Full Step

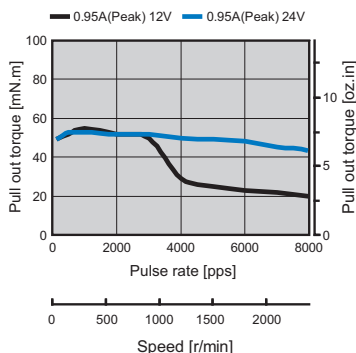

### 11HS5003

Conditions: Uni-polar Constant Current Driver  
Driver: AMA MSU3040M  
Mode: Full Step

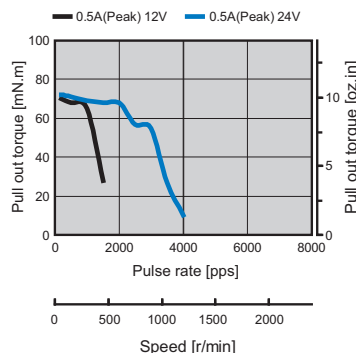

Why Stepping Motor

encapsulated 2 phase NEMA 14

encapsulated 3 phase NEMA 14 NEMA 17

new release 2 phase NEMA 8

new release 2 phase NEMA 14

new release 2 phase NEMA 16

2 phase NEMA 10 25.0 mm (1.00 inch)

2 phase NEMA 11 28.0 mm (1.10 inch)

2 phase NEMA 14 35.0 mm (1.38 inch)

2 phase NEMA 16 39.0 mm (1.53 inch)

2 phase NEMA 17 42.0 mm (1.65 inch)

2 phase NEMA 23 56.0 mm (2.22 inch)

2 phase NEMA 24 60.0 mm (2.36 inch)

2 phase NEMA 34 86.0 mm (3.39 inch)

3 phase NEMA 24 60.0 mm (2.36 inch)

3 phase NEMA 34 86.0 mm (3.39 inch)

how to select