

# Brushless DC Motors with Integral Drive

## KinetiMax 42 EB Series

*42 mm diameter, 70 mNm max. torque, up to 31 W output power*

The KinetiMax 42 EB is an extremely compact brushless DC motor with integrated drive electronics. This motor is an outer rotor motor with a robust bearing system capable of handling high side loads.

High quality components ensure a minimum operating life of 20.000 hours. The continuous output torque of 70 mNm at a constant speed of 4300 RPM makes this motor ideal for small membrane and peristaltic pumps, blower fan and medical applications.



### Options & Accessories

- Customized shaft
- Double shaft version, with front and back shaft
- Customized mounting flange
- Custom leads and connector configurations
- Special winding configurations
- Motor with Hall sensors on
- Encoder and/or gearbox

### Features & Benefits

- 42 mm diameter outer rotor, brushless DC motor with integrated drive and robust bearing system
- Rated 70 mNm (9,9 oz-in) and 31 W output at 4300 RPM
- 12 or 24 VDC winding choice
- Integrated speed control loop with a speed set input to adjust motor speed from 150 to 5000 RPM
- 6-wire version with tachometer output (18 pulses per rev) for speed monitoring, speed input and direction input.
- IP54 level protection sealing
- Thermal overload protection with automatic recovery
- Reverse supply voltage protection
- Low EMI – complies with EN 55014-1/2, 61000-6-1/3

## KinetiMax 42 EB – Specifications

Shaft Diameter	4 mm	4322-016-38002	4322-016-38007
	5 mm	4322-016-38003	4322-016-38008
	6 mm	4322-016-38004	4322-016-38009
Voltage VDC	Nominal	12	24
	Range <sup>1</sup>	10 – 18	10 – 28
Rated Output Power	W	29	32
Torque mNm (oz.in.)	Rated	70 (9.9)	
	Max	72 (10.2)	100 (14.2)
Speed RPM	Rated	4300	
	No-load	5200	5300
Current	Rated	A	3.5
	Max	A	3.6
	No-load	mA	460
Rotor Inertia kgm <sup>2</sup> (oz.in.s <sup>2</sup> )	17.5 E-6 (26 E-4)		
Thermal Resistance °C/W	Housing-Ambient	7.6	
Weight g (oz)	225 (4.0)		
Protection Level	IP54		
Speed Command	Ratio	RPM/V	1000
	Range	V	0 – 7
	Threshold	V	0.1
Direction Input V	CW	Low <1	
	CCW	High >4	
Speed Output	Pulse Rate	PPR	18
	Low Time	µsec	195
Operating Temperature Range °C (°F)			
Thermal Limit Protection	°C (°F)	90 (194 ) flange temp. / 80 (176) restart	

Values valid for nominal voltage and  $T_{amb} = 22^{\circ}\text{C}$

<sup>1</sup> Power supply provided with appropriate 1000 µF buffer capacitor between supply voltage and common to comply with EN 55014-1/2; protection against wrong connection up to ±28 volt

# KinetiMax 42 EB – Performance

## 12V Models

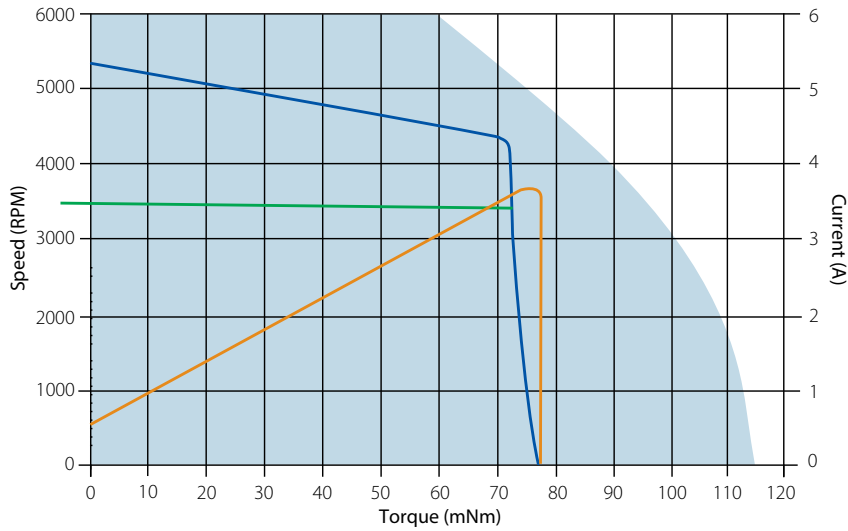

## 24V Models

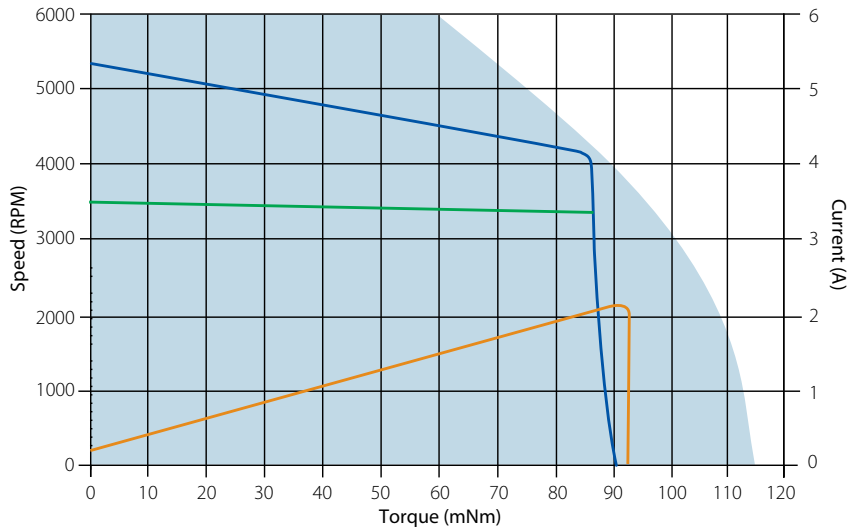

	Open Loop Speed*
	Open Loop Current*
	$V_{in} = 3.5V$
	Continuous Operation **

\* @ Rated Voltage

\*\* @ 22°C

## KinetiMax 42 EB – I/O Schematics

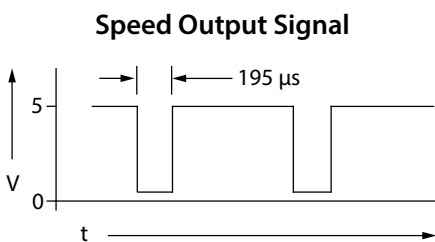
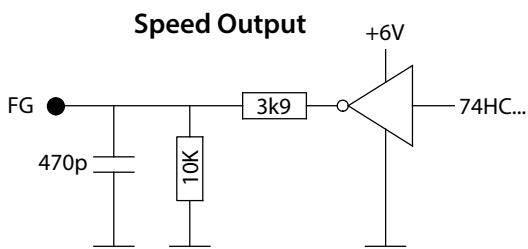
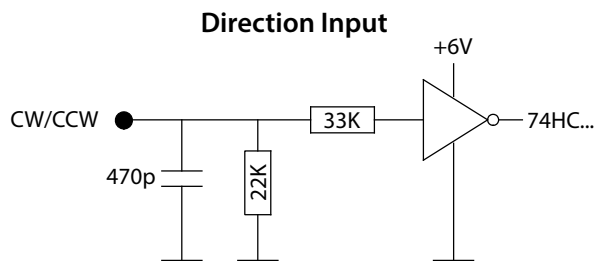
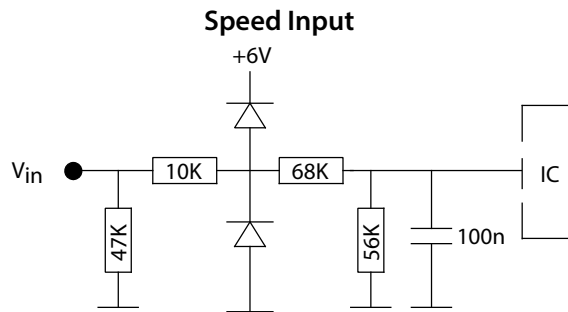

### EMC

To meet EMC directive EN 55014, the power supply must be provided with a capacitor 1000  $\mu$ f, 35V at the output:

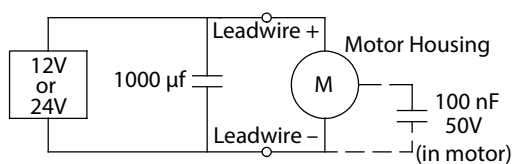

## KinetiMax 42 EB – Electrical Connections

Version	Description	Wire Color (AWG 24)	
6-Wire	1	Supply Voltage	Red
	2	Ground	Black
	3	Tachometer Output (FG)	Green
	4	Speed Control Input ( $V_{in}$ )	White
	5	Direction Input (CW/CCW)	Brown
	6	Shield	Yellow

## KinetiMax 42 EB – Dimensions — mm (in)

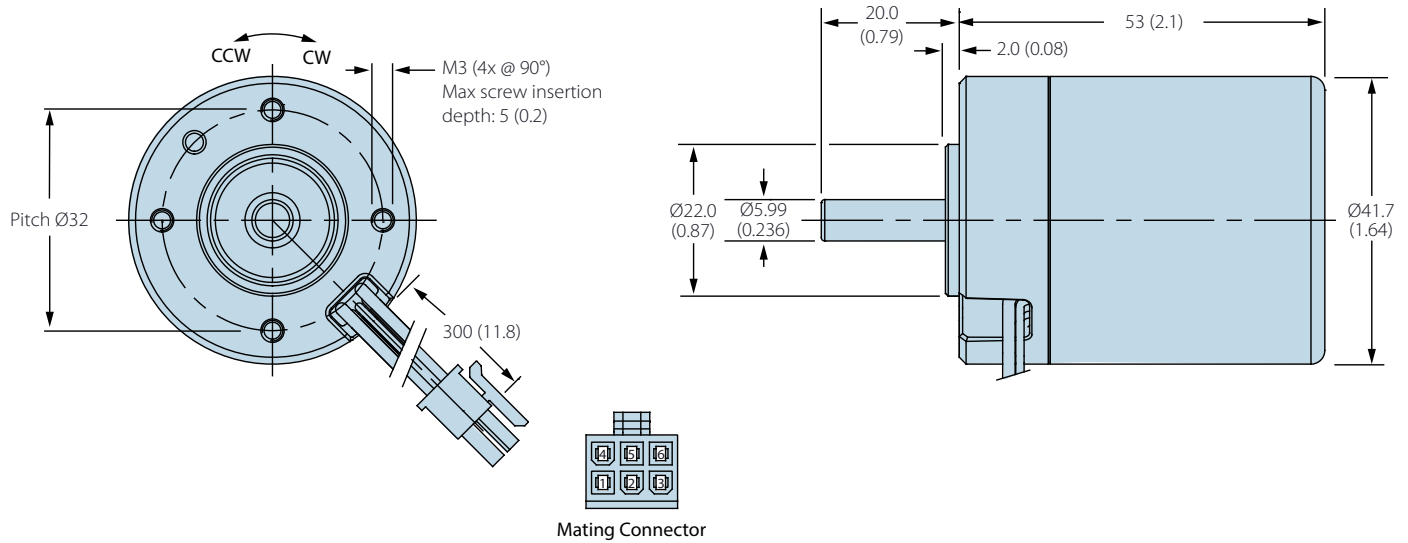

Your Distributor:



**Antriebstechnik GmbH**

Starkenburgerstr. 6 \* 64546 Mörfelden

Tel.: 06105 24044 \* Fax: 06105 25593

info@color-technik.net

[www.color-technik.net](http://www.color-technik.net)

## Custom & Specific-Purpose Products & Sub-Assemblies

Allied Motion offers a very wide selection of standard motion control solutions to satisfy the requirements found in the commercial, industrial and aerospace and defense markets. And, we are adding new products every year to meet new demands we find in those markets.

However, a recognized strength of Allied Motion is our willingness and ability to develop custom motion control products and systems to meet the specific needs of customers. Please contact us to discuss your specialized application requirements.

## Allied Motion Solution Centers

Allied Motion maintains Solution Centers in three geographically strategic locations to assist our customers with all aspects of their product selection and buying decisions. These facilities assure local support no matter your location around the globe.

Each Solution Center's experienced application engineering and customer service team provide:

- Application analysis assistance
- Detailed product information and documentation
- Standard product selection
- Product customization and options guidance
- Specification development assistance for custom-design products
- Price quotations
- Ordering, order status and shipment information
- Logistics assistance

For assistance with your project, contact us at one of our continental Allied Motion Solution Centers listed below.

Allied Motion also has a global network of factory trained selling partners to serve you. Visit our website for contact information for the Allied Motion Sales Partner nearest you.



## High-Performance Specialty Motors & Application-Specific Motion Systems

Aerospace & Defense  
Automation  
Commercial-Consumer  
Industrial  
Medical  
Pumps  
Robotics  
Vehicles

[www.alliedmotion.com](http://www.alliedmotion.com)

## North America

United States, Canada, Mexico:

### Allied Motion Technologies NASC

495 Commerce Drive  
Amherst, NY 14228 USA

+1 (716) 242-7535

[inquiry@alliedmotion.com](mailto:inquiry@alliedmotion.com)

## Europe

UK, Ireland, continental Europe,  
Eastern Europe, Scandinavia, Israel:

### Allied Motion Technologies EUSC

Ekbacksvägen 26, PO Box 11198  
S-161 11 Bromma, Sweden

+46 (8) 546 111 00

[inquiry@alliedmotion.com](mailto:inquiry@alliedmotion.com)

## Asia

China, Taiwan, Japan, S. Korea, and  
other Far East Countries:

### Allied Motion Technologies ASC

58 Leshan Road  
Xinbei District, Changzhou 213022  
China

+852 2607 4038 +86 519 85113625

[inquiry@alliedmotion.com](mailto:inquiry@alliedmotion.com)